

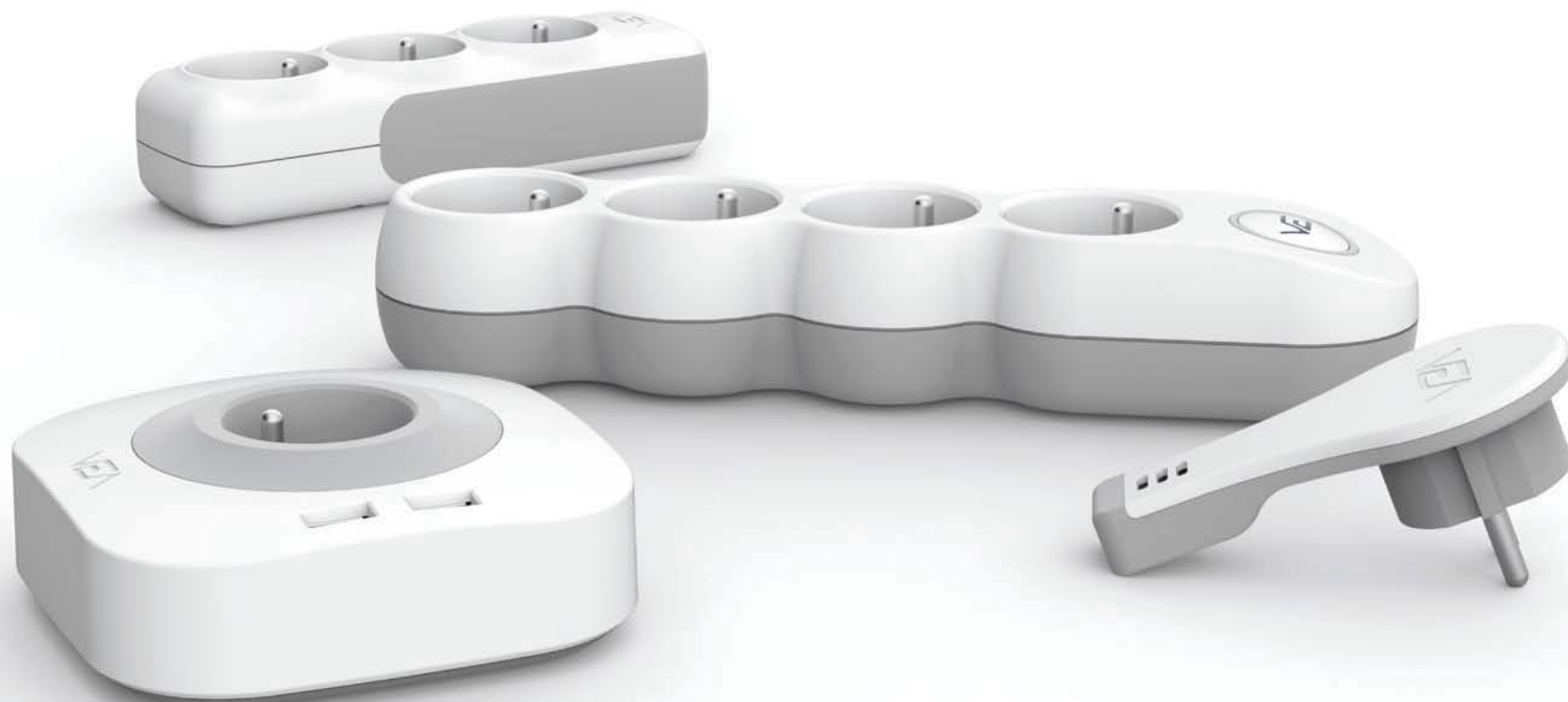

# Nothing has to be conventional

Electrical Accessories – International Design with Nonconventional Approach



# Nothing has to be conventional

We keep looking for places where design has been forgotten... In VEA, we believe that each product can and should be **beautiful and functional at the same time**. With this approach in mind — unusual as it may seem for our industry — we created the first five product lines presented in this catalogue. And this is just the beginning... **It's time for electrical products combining simple functions with top level design to become available for everyone.**



# VEA is present in every corner of the continent.

Excellent design and innovation in product development are highly valued all over Europe. **VEA's partners are leading distributors in the electrotechnical industry who understand and respect our concepts and our unique type of cooperation.** It's thanks to them that VEA covers the whole continent and can supply its products to customers from every corner of Europe.

Welcome to our electrical world of beauty!





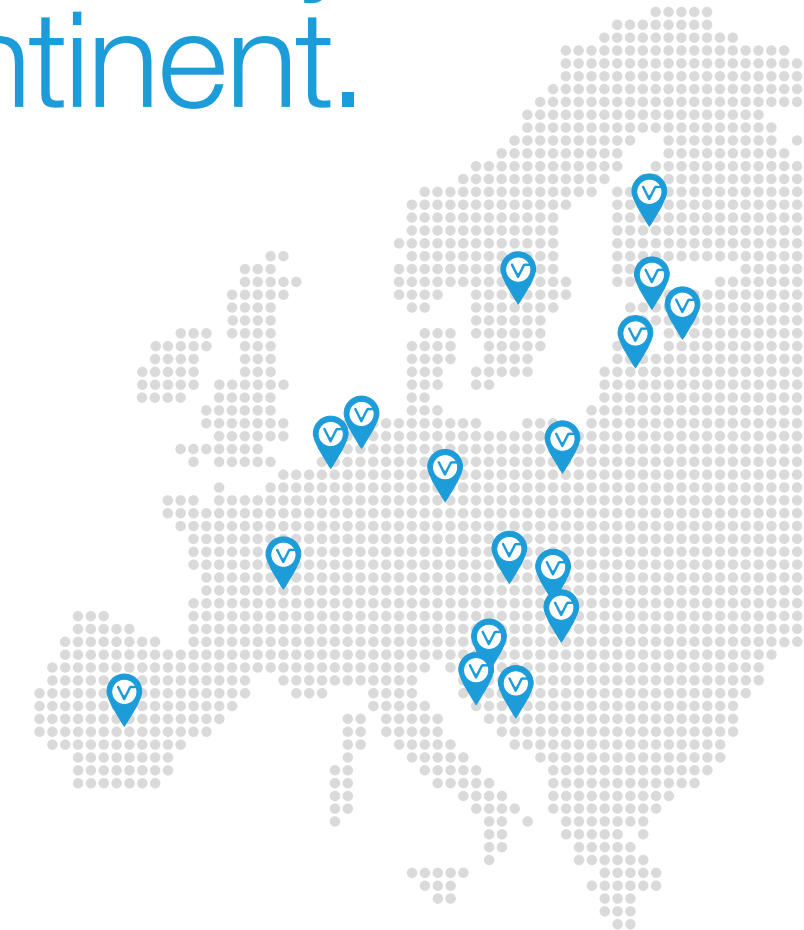

Jan Sobusiak / CEO

A handwritten signature in blue ink, which appears to read 'Jan Sobusiak'. The signature is fluid and cursive.



# Table of contents



	Flat Plug	05
	VEA I	07
	VEA II	11
	Multi Power Socket	17
	USB	19
	Display Stands	21



# Flat Plug

A plug so flat that it doesn't get in anybody's way.



## Details

With the 4 colours available, the plug is not conspicuous but blends in with the background. It is not protruding so you can push your sofa closer to the wall.



The flat plug complements perfectly the functionality of VEA products and brings neatness and elegance to the room.

Michał Bonikowski / CTO

*With the flat back, the plug virtually "hides" in the wall*

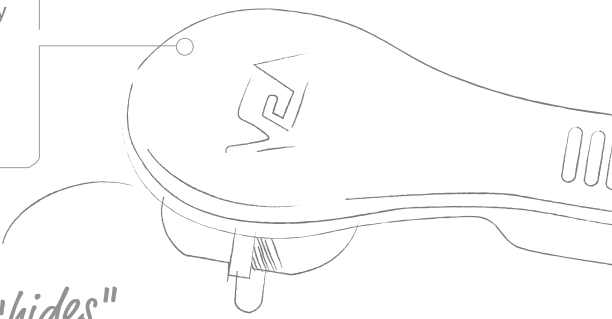

### A plug which combines functionality with aesthetics!



VA1WG



VA1WW



VA1GG



VA1BB

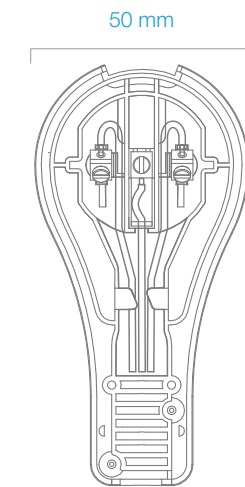

50 mm

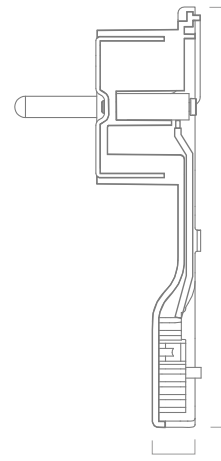

170 mm

10 mm



# VEA I

Nothing has to be conventional

## Details

5 colour versions and 3 cord lengths with thoughtfully designed sockets and practical details. Available with flat and regular plugs.



A play of colours that paints the room. It comes with a smart socket design and a simple fixing system.

Michał Winowiecki / CCO

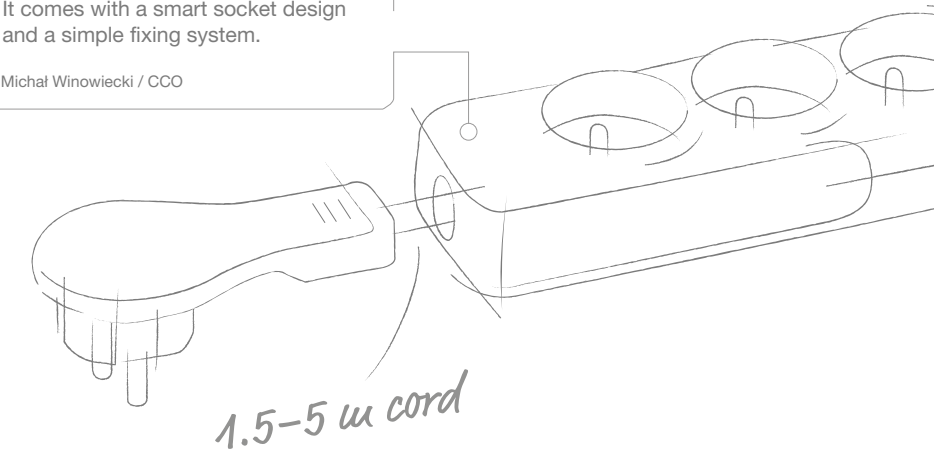

And what is missing?  
Nothing except for monotony and boredom.

### Specification

- socket type: FR / SCHUKO
- cord length: 1.5 m, 3 m, 5 m
- number of sockets: 3
- colour:

### Features



V-clip fixing system



45 degrees with the last socket at 0 degrees.



practical, detachable hanger















child protection













## French

Each model is available in three lengths: 1.5 m, 3 m, 5 m and with two cord types: H05VV-F3G1.5MM2 / H05VV-F3G1.0MM2

					
	VE1F3NWGR	VE1F3NWBL	VE1F3NWGE	VE1F3NWYE	VE1F3NWBR
					
	VE1F3NWGR/FP	VE1F3NWBL/FP	VE1F3NWGE/FP	VE1F3NWYE/FP	VE1F3NWBR/FP

## Schuko

Each model is available in three lengths: 1.5 m, 3 m, 5 m and with one cord type: H05VV-F3G1.5MM2

					
	VE1S3NWGR	VE1S3NWBL	VE1S3NWGE	VE1S3NWYE	VE1S3NWBR
					
	VE1S3NWGR/FP	VE1S3NWBL/FP	VE1S3NWGE/FP	VE1S3NWYE/FP	VE1S3NWBR/FP



# VEA II

Functionality  
by design



## Details

In every home, there are always too few power sockets and more and more devices to be connected. We do not just want to provide an extension.



The large switch at the front is always easily accessible when you need it. The flat plug and the long cord make VEA II a perfect extension cord.

Michał Bonikowski / CTO

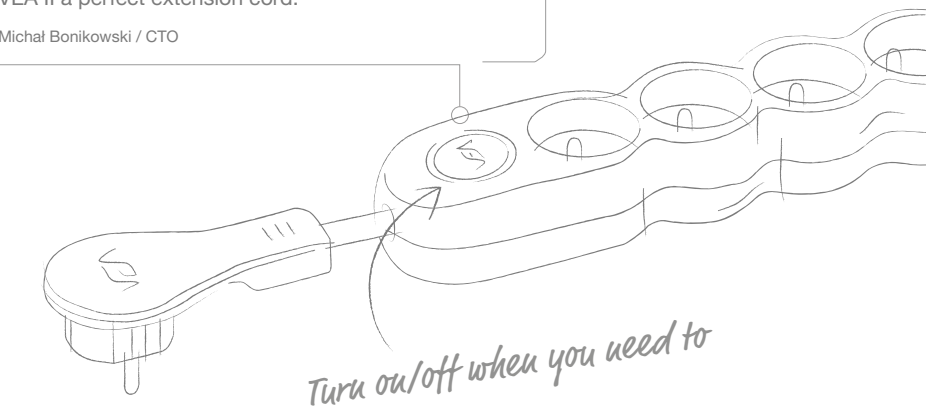

A thoroughly designed port for additional 3 to 5 devices.



### Specification

- socket type: FR / SCHUKO
- cord length: 1.5 m, 3 m, 5 m
- number of sockets: 3-5
- colour:

### Features



V-clip fixing system



45 degrees with the last socket at 0 degrees.



practical, detachable hanger



child protection



## French

Each model is available in three lengths: 1.5 m, 3 m, 5 m and with two cord types: H05VV-F3G1,5MM2 / H05VV-F3G1,0MM2

						
	VE2F3NWGR	VE2F4NWGR	VE2F5NWGR	VE2F3SWGR	VE2F4SWGR	VE2F5SWGR
						
	VE2F3NWGR/FP	VE2F4NWGR/FP	VE2F5NWGR/FP	VE2F3SWGR/FP	VE2F4SWGR/FP	VE2F5SWGR/FP

## Schuko

Each model is available in three lengths: 1.5 m, 3 m, 5 m and with one cord type: H05VV-F3G1,5MM2

						
	VE2S3NWGR	VE2S4NWGR	VE2S5NWGR	VE2S3SWGR	VE2S4SWGR	VE2S5SWGR
						
	VE2S3NWGR/FP	VE2S4NWGR/FP	VE2S5NWGR/FP	VE2S3SWGR/FP	VE2S4SWGR/FP	VE2S5SWGR/FP





## French

Each model is available in three lengths: 1.5 m, 3 m, 5 m and with two cord types: H05VV-F3G1.5MM2 / H05VV-F3G1.0MM2

						
	VE2F3NBBL	VE2F4NBBL	VE2F5NBBL	VE2F3SBBL	VE2F4SBBL	VE2F5SBBL
						
	VE2F3NBBL/FP	VE2F4NBBL/FP	VE2F5NBBL/FP	VE2F3SBBL/FP	VE2F4SBBL/FP	VE2F5SBBL/FP

## Schuko

Each model is available in three lengths: 1.5 m, 3 m, 5 m and with one cord type: H05VV-F3G1.5MM2

						
	VE2S3NBBL	VE2S4NBBL	VE2S5NBBL	VE2S3SBBL	VE2S4SBBL	VE2S5SBBL
						
	VE2S3NBBL/FP	VE2S4NBBL/FP	VE2S5NBBL/FP	VE2S3SBBL/FP	VE2S4SBBL/FP	VE2S5SBBL/FP

# Multi Power Socket

A multi-plug adaptor which gives **multiple choices!**

## Details

Kitchen or bathroom, living room or bedroom, there are always too few power sockets and too many devices to be connected in the very same spot. With this double, triple and fourfold power socket, the problem is solved!



A stylish problem-solver. This simple appliance is a truly decorative item. A multi-plug adaptor which gives multiple choices!

Michał Winowiecki / CCO

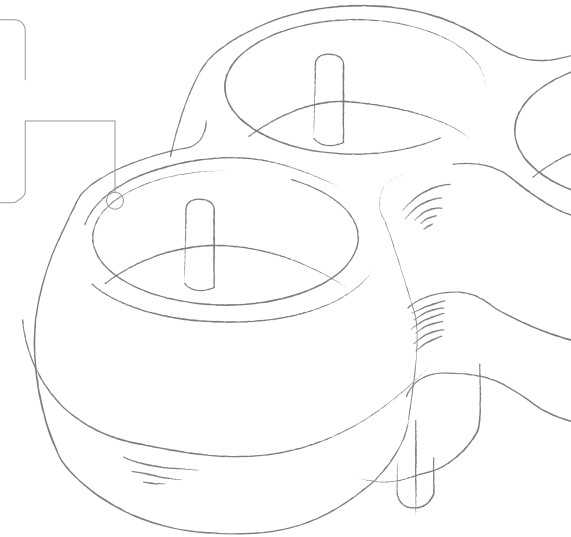

### A multi-plug adaptor which gives multiple choices!



VE2AF2WG



VE2AF3WG



VEA2AF3WG/U



VEA2AF3WG/S



# USB

2 necessary power sources always in 1 place



## Details

1 power outlet and 2 USB ports — always close at hand. More and more devices are charged via a USB port. VEA USB will surely appeal to active users of modern electronics.



An extension cord and USB ports enclosed in a perfect, functional form. It's a must on every desk.

Michał Bonikowski / CTO

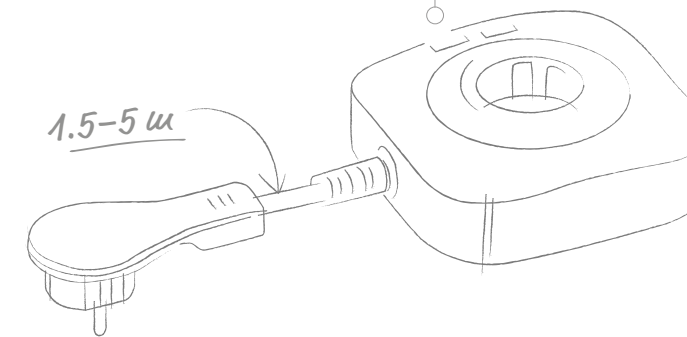

- socket type: FR / SCHUKO
- cord length: 1.5 m, 3 m, 5 m
- number of sockets: 1 power, 2 USB
- colour: ● ●

### French

Each model is available in three lengths: 1.5 m, 3 m, 5 m and with two cord types: H05VV-F3G1.5MM2 / H05VV-F3G1.0MM2

	 VAUF2WGR	 VAUF2BBL
	 VAUF2WGR/FP	 VAUF2BBL/FP

### Schuko

Each model is available in three lengths: 1.5 m, 3 m, 5 m and with one cord type: H05VV-F3G1.5MM2 / H05VV-F3G1.0MM2

	 VAUS2WGR	 VAUS2BBL
	 VAUS2WGR/FP	 VAUS2BBL/FP



# Display Stands

A well-thought display, functionality and simple usage

The VEA stand is robust and handy. Thanks to the modular design and the branding space, it fits every point of sale.



## Number of products in the cell units



A: 590 x 390 x 275 mm



B: 590 x 390 x 275 mm



D: 590 x 300 x 200 mm

## Arrangement examples



C + D



A + C + D



A + B + D



A + B + C + D



A + B + B + C + D



A + B + B + B + C + D



**vea**international™

—

office@vea-international.com  
vea-international.com